

P/N:110401111679X

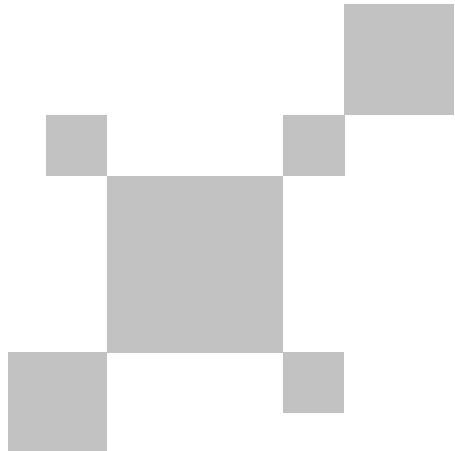

UNI-T
UNI-TREND TECHNOLOGY (CHINA) CO., LTD.
No. 6, Gong Ye Bei 1st Road,
Songshan Lake National High-Tech Industrial
Development Zone, Dongguan City,
Guangdong Province, China

UNI-T[®]

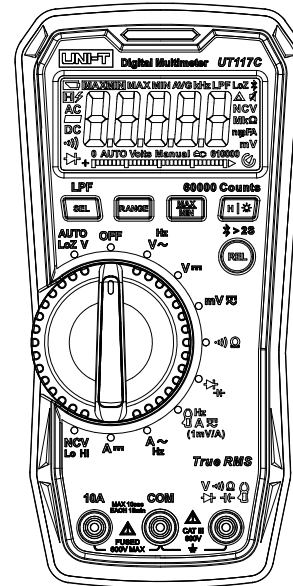

UT117C
High-Precision True RMS Digital Multimeter
User Manual

Preface

Thank you for purchasing this brand new product. In order to use this product safely and correctly, please read this manual thoroughly, especially the safety notes.

After reading this manual, it is recommended to keep the manual at an easily accessible place, preferably close to the device, for future reference.

Limited Warranty and Liability

Uni-Trend guarantees that the product is free from any defect in material and workmanship within one year from the purchase date. This warranty does not apply to damages caused by accident, negligence, misuse, modification, contamination or improper handling. The dealer shall not be entitled to give any other warranty on behalf of Uni-Trend. If you need warranty service within the warranty period, please contact your seller directly.

Uni-Trend will not be responsible for any special, indirect, incidental or subsequent damage or loss caused by using this device.

Contents

I. Overview	4
II. Features	4
III. Accessories	5
IV. Safety Information	5
V. Electrical Symbols	6
VI. General Characteristics	6
VII. External Structure	7
VIII. Rotary Switch	8
IX. Button Descriptions	9
X. LCD Display	10
XI. Operating Instructions	11
XII. Other Functions	18
XIII. Technical Specifications	19
XIV. Use of Bluetooth software	24
XV. Use of magnetic hanger (UT-B23)	25
XVI. Maintenance and Repair	27

I. Overview

The user manual includes related safety information and warning prompt. Please read the instructions carefully and strictly follow all warning and precautions.

⚠ Warning: Before use, please read the safety information carefully.

UT117C is a handheld 60000-count multimeter with high reliability and safety. It adopts high-resolution A/D converter and microcontroller data processing technology. UT117C is designed with digital LCD, overload protection across all ranges and unique appearance, making it a safer electrical meter with superior performance. Characterized by intelligent, high-precision, high-performance and multifunction, it can measure or test parameters below:

- AC/DC voltage
- AC voltage, current frequency
- Low pass filter (LPF)
- AC/DC current
- Continuity
- Resistance
- Diode
- Capacitance
- Connected with current probe externally
- NCV
- AUTO-V LOZ

UT117C has multiple functions including auto range, data hold, MAX/MIN/Average measurement, REL measurement, low voltage indication, audible and visual alarm, backlight and auto power off, and Bluetooth.

II. Features

- True RMS to ensure accurate measurement of non-linearity load
- The ability to measure 20A (10 seconds of transient measurement)
- LoZ function: Low impedance to prevent incorrect reading caused by ghost voltage
- AutoVolt (Select DC/AC voltage automatically)
- LPF function to ensure accurate measurement of voltage and frequency of variable speed drive (VSD)
- Measure resistance, continuity, frequency and capacitance
- Display MAX/MIN/Average values so as to record signal fluctuation
- White backlight to enable user to read displayed data in dark environments
- Has Bluetooth communication function. Through UNI-T smart measurement APP, testing results can be record and reported, and the APP can generate data diagram and chart.
- Ergonomic design for one-handed operation

- Optional magnetic hanging strap to enable performing measurement without holding the multimeter by hand.
- The current of conductor can be measured without changing or disconnecting the circuit, by connecting current probe externally.
- Drop proof: 2m
- CAT III 600V
- The user manual includes related safety information and warning prompt. Please read the instructions carefully and strictly follow all warning and precautions.

III. Accessories

Open the package to check the accessories shown below. Please contact your supplier if any of them is founded missing or damage. Standard accessories:

- User manual ----- 1 pc
- Test lead ----- 1 pair
- 1.5V AAA battery ----- 3 pcs
- Magnetic hanger ----- 1 set
- UT-CS06A AC current probe (optional) ----- 1 pc

IV. Safety Information













Please pay attention to “Warning labels and sentences”. The warnings identify the operation may pose danger to user and cause damage to the multimeter or measured equipment.

The meter is in compliance with IEC/EN61010-1, 61010-2-033, Electromagnetic Radiation EN61326-1 Safety Standard, Double Insulation Standard, Overvoltage CAT III 600V, and Pollution Class 2. Failure to follow the operating instructions may compromise or lose the protection provided by the multimeter.

- Before use, please check the multimeter and test leads so as to prevent any damage or abnormal case. Please stop use if any abnormal case occurs, for example, test leads are exposed, casing is damaged, black screen or abnormal display occurs, or others. It is forbidden to use without cover closed in place, otherwise it may present a risk of electric shock.
- In case of damaged test leads, please replace by test leads same with model or electrical specification.
- Do not make contact with exposed wire, connector, unused input terminal or circuit during use.
- Use cautious when working with voltage over DC/AC 30V, please grip the test lead behind the finger guard to avoid electric shock.
- Set the multimeter at maximum range if the measured range is unknown.
- Do not apply overrated voltage or current between terminals, or between any terminal and grounding.
- Set the rotary switch to correct range. Disconnect test lead with measured circuit before switching the functional switch. It is forbidden to switch over during measurement, so as to avoid damage to the multimeter.

- Before measuring on-line resistance, diode or continuity, please switch off all powers of measured devices, and discharge all capacitors completely.
- Before measuring current, please check if the fuse of the multimeter is good, and switch off the measured current before connecting the multimeter with circuit, to avoid a risk of electric spark.
- Do not keep or use the multimeter in environments with high temperature, high humidity, inflammable and explosive substance, and strong electromagnetic fields.
- Do not alter the internal wiring without authorization to avoid damage to the multimeter.
- When the symbol “” shows on the LCD, please replace the battery in time to ensure measurement accuracy.
- Turn off the power in time after measurement. Remove the battery if the multimeter is not used for a long time.

V. Electrical Symbols

Symbol	Description	Symbol	Description
	Do not place equipment and its accessories in the trash. Please dispose properly according to the local regulation.		Double insulated
	AC (Alternating Current)		Grounding
	DC (Direct Current)		Warning
	Fuse		Low battery
	Bluetooth communication		UKCA certification mark
	Conform to European Union standards		
	Conform to UL STD 61010-1, 61010-2-032 Certified to CSA STD C22.2 NO. 61010-1, 61010-2-032		
CAT III	Applicable to test and measure the circuit connected with the power distribution part of building's low-voltage MAINS installation.		
CAT IV	Applicable to test and measure the circuit connected with the power supply of building's low-voltage MAINS installation.		

VI. General Characteristics

- Maximum voltage between signal input terminal and COM terminal: See voltage input protection instruction for each range
- Designed with 10A input terminal: Fuse 11A/1000V (energy: 30KA) Φ10.3×38mm
- Display count: 60000
- Display uprate rate: About 5 times per second

- Analog bar graph: 33 segments. Update for 32 times per second.
- Range: Auto/Manual
- Polarity display: Auto
- Overrange indication: OL
- Low voltage indication: (About $\leq 3.6 \pm 0.2V$)
- Operating temperature: $0^{\circ}C \sim 40^{\circ}C$ ($32^{\circ}F \sim 104^{\circ}F$)
- Storage temperature: $-10^{\circ}C \sim 50^{\circ}C$ ($14^{\circ}F \sim 122^{\circ}F$)
- Relative humidity: $\leq 75\%$ ($0^{\circ}C \sim 30^{\circ}C$ below); $\leq 50\%$ ($30^{\circ}C \sim 40^{\circ}C$)
- Operating altitude: $\leq 2000m$
- EMC: Conform to EN61326-1
- Battery: 1.5V AAA x 3 (4.5V)
- External dimensions: 169mm x 84mm x 48.8mm
- Weight: About 346g (including battery)
- Safety standard: IEC 61010-1: CATIII 600V

VII. External Structure

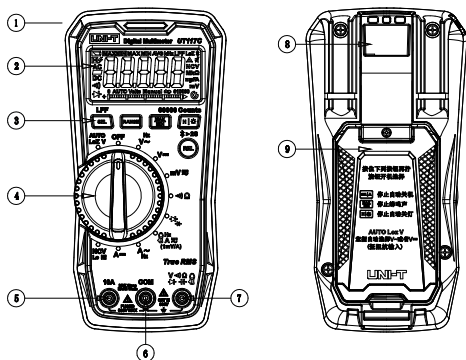

Figure 1

1. NCV sensing end
2. LCD display
3. Functional buttons: Used to select measurement functions
4. Rotary switch
5. A terminal
6. COM terminal
7. V terminal
8. Holder for magnetic hanger
9. Battery cover and support

VIII. Rotary Switch

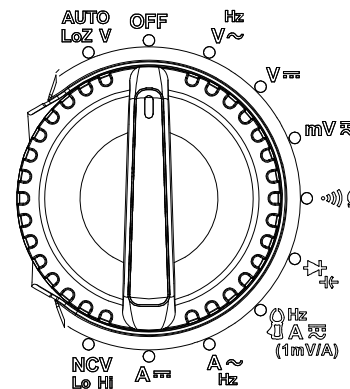

Figure 2

OFF	Power off
Auto-V LoZ	LOZ auto AC/DC voltage measurement
V \sim /HZ	AC voltage/ frequency measurement. Long press the SEL button to enable LPF function.
V \equiv	DC voltage measurement
mV \equiv	mV AC/DC voltage measurement
$\cdot\cdot\cdot\Omega$	Continuity/Resistance measurement
$\rightarrow\leftarrow$	Diode/Capacitance measurement
Hz A	Externally connected current probe measurement
A \sim /HZ	AC current measurement
A \equiv	DC current measurement
NCV	NCV detection

IX. Button Descriptions

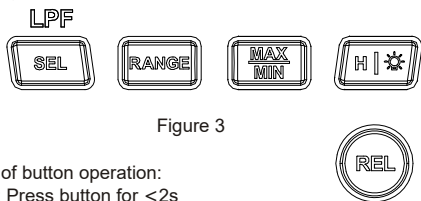

Figure 3

Instructions of button operation:
 Short press: Press button for <2s
 Long press: Press button for ≥2S

Button	Description
SEL/LPF	1) Short press: Select testing functions including ACV/Hz, ACA/Hz, AC/DCmV, continuity/resistance, diode/capacitance, ACA/Hz/DCA (current probe measurement), NCVLO/HI. 2) Long press in ACV/Hz position to enter or exit LPF function cyclically. 3) Note: The SEL button is disabled in HOLD, MAX/MIN/AVG modes.
RANGE	1). Short press this button once to enter manual range mode ("AUTO" is not displayed on the LCD) and show current range, short press again to select range. Long press to exit manual range and enter auto range. Default setting will be recovered when switching position or restarting the multimeter. 2) Under frequency measurement mode, short press this button to select the range of ACV/ACA (equivalent to the RANGE function corresponding to ACV/ACA). 3) RANGE button is disabled in HOLD, MAX/MIN and REL modes.
MAX/MIN	1) Short press this button to enter "MAX/MIN" statistics mode, refresh data continuously and view "MAX→MIN→AVG→Current measurement value→MAX...". Long press to exit statistics mode and return to normal working mode. (For ACV, DCV, Ω, CAP, continuity and current probe only) 2) In HOLD mode, MAX/MIN button is disabled. 3) Press REL button and then short press MAX/MIN button to calculate the MAX/MIN value subtracted by least significant digit. 4) In LPF mode, press MAX/MIN button to calculate the MAX/MIN value. 5) When the multimeter enters statistics mode, it exits auto range and enters current range, the symbol "Manual" flashes four times at a frequency of 2Hz, and the auto-off function is disabled. To restore auto range and auto-off function, please exit MAX/MIN mode (If the auto-off function is disabled manually, the multimeter will keep this function in disabled state). 6) In statistics mode, short press HOLD to stop refreshing data, then view MAX/MIN value by pressing MAX/MIN button. Short press HOLD again to exit the HOLD mode and then refresh data. 7) MAX/MIN button is disabled in Auto-V LoZ mode.

HOLD/Backlight	1) Short press this button to enter or exit data hold mode. In HOLD mode, they symbol "H" is displayed on the LCD. 2) Long press to turn on/off the backlight. The backlight is turned off automatically in 5 minutes by default.
REL/BT	1) Short press this button to enter or exit REL mode. The LCD shows the symbol "△" in REL mode. (For ACV, DCV, Ω, CAP, continuity, diode and current probe only) 2) When the multimeter enters REL mode, it exits auto range and enters current range, and the symbol "Manual" flashes four times at a frequency of 2Hz 3) Under REL mode, the actual measureable scope at current range is not changed. 4) REL button is disabled in HOLD and MAX/MIN modes. 5) REL button is disabled in Auto-V LoZ mode. 6) Long press to turn on/off Bluetooth.

X. LCD Display

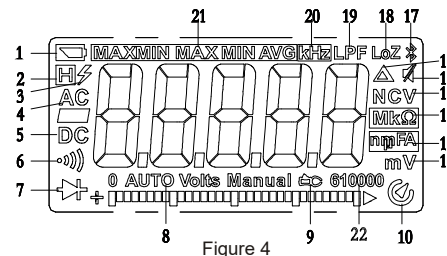



Figure 4

1	Low voltage	2	Data hold
3	Dangerous voltage	4	AC measurement
5	DC measurement	6	Continuity measurement
7	Diode measurement	8	Auto range
9	Externally-connected current probe	10	Auto power off
11	Voltage unit	12	Current/capacitance unit
13	Resistance unit	14	NCV detection
15	Buzzer	16	REL measurement
17	Bluetooth	18	LOZ measurement
19	LPF	20	Frequency unit
21	MAX/MIN/Average measurement	22	Measurement range

XI. Operating Instructions

Please check the batteries (AAA 1.5V × 3) before use. If the battery power is low after the multimeter is powered on, the symbol “” will be displayed on the LCD. To ensure measurement accuracy, please replace the battery in time. The warning symbol “” at the terminals indicates the measured voltage or current cannot exceed the specified value.

1. Automatic AC/DC voltage measurement (Auto-V LoZ) (Figure 5)

- 1) Connect red test lead with V terminal, and black with COM.
- 2) Set the rotary switch to Auto-V LoZ, then connect test lead with measured power source or load in parallel.
- 3) Read the measured voltage from LCD. For Auto-V LoZ measurement, the multimeter selects AC/DC voltage automatically according to the detected low impedance.

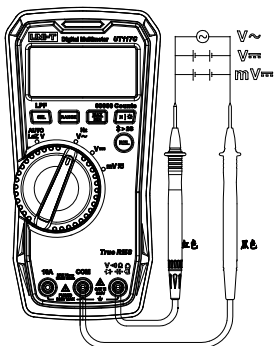



Figure 5

Warning:

- To eliminate ghost voltage, the whole circuit is designed with a low impedance (input impedance is about 3kΩ).
- Do not input voltage over 600V. It is possible to measure higher voltage, but the protection provided by the multimeter can be compromised.
- Pay special attention to avoid electric shock when working with high voltage.
- To check if the multimeter can function well, please measure a known voltage before use.
- If the measured voltage is >30V (AC/DC), the high voltage symbol “” appears; if >600V (AC/DC), the buzzer sounds consecutively and the red light is lit up.
- Disconnect the test lead with measured circuit after all measurement operations are completed.

2. AC/DC voltage measurement (Figure 5)

- 1) Connect red test lead with V terminal, and black with COM.
- 2) Set the rotary switch to ACV or DCV position, select function (ACV or DCV) corresponding to measurement signal, then connect test lead with power source or load in parallel.
- 3) Read the measured voltage from the LCD.
- 4) In ACV position, long press SEL to enable LPF function. Composite sinusoidal signal generated by inverter or variable-frequency motor can be measured through the LPF function, as shown in Figure 6 below Long press SELECT again to exit LPF function.

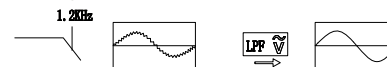

- 5) When measuring ACV or ACV_LPF, short press SELECT to switch to measure frequency of voltage, then read the frequency of measured voltage. For measuring frequency of voltage, the amplitude of input voltage shall be greater than 10% of full range, see “Technical Specifications” for details.
- 6) For frequency detection, analog bar graph and range annunciator can indicate the current AC voltage, and relatively low range can be selected asymptotically through manual range function, so as to obtain a stable reading.

Warning:

- The input impedance of the multimeter is about 10MΩ. Measurement error will be produced when measuring circuit with high impedance. In most cases, the impedance of circuit is below 10KΩ, thus error of 0.1% or less can be negligible.
- Do not measure input voltage over the range, otherwise correct reading cannot be obtained and product damage and personal injury may occur.
- Do not input voltage over 600V. It is possible to measure higher, but the protection provided by the multimeter can be compromised.
- Pay special attention to avoid electric shock when working with high voltage.
- To check if the multimeter can function well, please measure a known voltage before use.
- If the measured voltage is >30V (AC/DC), the high voltage symbol “” appears; if >600V (AC/DC), the buzzer sounds and the red light is lit up.
- Disconnect the test lead with measured circuit after all measurement operations are completed.

3. AC/DC mV voltage measurement (Figure 5)

- 1) Connect red test lead with V terminal, and black with COM.
- 2) Set the rotary switch to AC/DC mV position, short press SEL to switch to ACmV or DCmV measurement mode, then connect test lead with measured power source or load in parallel.
- 3) Read the measured voltage from the LCD.

⚠ Warning:

- The input impedance of the multimeter is about 10MΩ. Measurement error will be produced when measuring circuit with high impedance. In most cases, the impedance of circuit is below 10KΩ, thus error of 0.1% or less can be negligible.
- Do not measure input voltage over the range, otherwise correct reading cannot be obtained and product damage and personal injury may occur.
- Do not input voltage over 600.0mV. It is possible to measure higher voltage, but the protection provided by the multimeter can be compromised.
- Pay special attention to avoid electric shock when working with high voltage.
- To check if the multimeter can function well, please measure a known voltage before use.
- If the measured voltage is >600V (AC/DC), the high voltage symbol "⚡" appears.
- Disconnect the test lead with measured circuit after all measurement operations are completed.

4. Continuity measurement (Figure 6)

- 1) Set the rotary switch to "•••Ω", then short press SEL to switch to continuity (•••) measurement.
- 2) Connect red test lead with V terminal, and black with COM. Then connect test lead with both ends of load of measured circuit in parallel.
- 3) Read from the LCD the resistance of load of measured circuit.

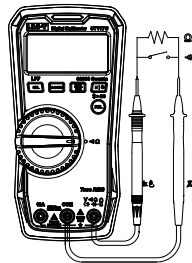

Figure 6

⚠ Warning:

- Audible and visual alarm (not in silent mode): If the resistance between both measured ends is $\leq 20\Omega$, the buzzer makes a long beep and the green light is lit up; if $>20\Omega$, the red light is lit up and the OL light is off.
- Before measuring on-line continuity, please switch off all powers of measured circuit, and discharge all capacitors completely.
- The open-circuit voltage is about 2V for continuity measurement.
- Do not input voltage over 30V (DC/AC) to avoid personal injury.
- Disconnect the test lead with measured circuit after all measurement operations are completed.

5. Resistance measurement (Figure 6)

- 1) Set the rotary switch to "•••Ω", then short press SEL to switch to resistance (Ω) measurement.
- 2) Connect red test lead with V terminal, and black with COM. Then connect test leads with both ends of measured resistor in parallel.
- 3) Read the measured resistance from the LCD.

⚠ Warning:

- "OL" will be displayed on the LCD if the measured resistor is open or the measured resistance is over the maximum range.
- Before measuring on-line resistance, please switch off all powers of measured circuit, and discharge all capacitors completely.
- If the resistance of shorted test lead is $\geq 0.5\Omega$, please check if test lead is loose or other problems occur.
- It is normal to take several seconds to stabilize the reading if the measured resistance is over 1MΩ.
- Do not input voltage over 30V (DC/AC) to avoid personal injury.
- Disconnect the test lead with measured circuit after all measurement operations are completed.

6. Diode measurement (Figure 7)

- 1) Set the rotary switch to "•••▶◀", then short press SEL to select diode measurement.
- 2) Connect red test lead with V terminal, and black with COM. The polarity of red test lead is "+", and black is "-". Connect red test lead with positive polarity of diode, and black with negative.
- 3) Read from the LCD the approximate forward voltage of PN junction of measured diode. The normal voltage of silicon PN junction is about 0.5~0.8V.

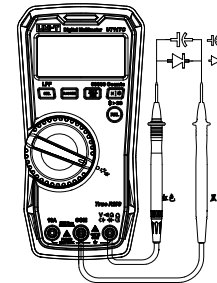

Figure 7

⚠ Warning:

- Audible and visual alarm (not in silent mode): For $< 0.12V$, the red light is lit up and the buzzer makes a long beep; for $\geq 0.12V$ and $< 2V$, the green light is lit up and the buzzer sounds once; for $>2V$, the light is off.

- “OL” is displayed if the measured diode is open or the polarity is reversed.
- Before measuring on-line diode, please switch off all powers of measured circuit, and discharge all capacitors completely.
- The open-circuit voltage for diode measurement is about 3.0V.
- Do not input voltage over 30V (DC/AC) to avoid personal injury.
- Disconnect the test lead with measured circuit after all measurement operations are completed.

7. Capacitance measurement (Figure 8)

- 1) Set the rotary switch to “ F ”, then short press SEL to select capacitance measurement.
- 2) Connect red test lead with V terminal, and black with COM. Then connect test leads with both ends of measured capacitor.
- 3) Read the measured capacitance from the LCD.

⚠ Warning:

- It is recommended to measure capacitor below 100nF in REL mode.
- “OL” is displayed on the LCD if the measured capacitor is shorted or the measured capacitance is over the maximum range.
- Please discharge capacitor completely before measurement (especially for capacitor with high voltage) to avoid product damage or personal injury.
- Disconnect the test lead with measured circuit after all measurement operations are completed.

8. Current probe measurement (ACA/DCA) (Figure 9)

- 1) Connect current probe with V terminal and COM terminal.
- 2) Set the rotary switch to “ A ”, then press SEL to select ACA/DCA measurement.
- 3) Read from the LCD the measured current of current probe. Under ACA mode of current probe, short press SEL to switch to frequency measurement in ACA mode of current probe, then read from the LCD the frequency of current.

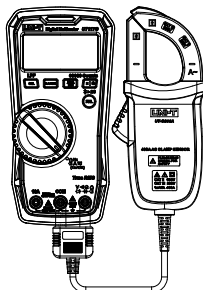

Figure 8

⚠ Warning:

- For frequency measurement under ACA mode of current probe, the input current amplitude shall be greater than 10% of full range.
- The frequency response is 45Hz~400Hz. For range at 600.0A: 1mV = 1A (AC/DC). The current probe measurement is an input mode of analog voltage, the specified accuracy and frequency response refer to the intrinsic accuracy and frequency response of UT117C (eliminate the error of current probe).
- Disconnect the test lead with measured circuit after all measurement operations are completed.

9. AC/DC current measurement (Figure 9)

- 1) Set the rotary switch to “ A ”, then press SEL to select ACA/DCA measurement.
- 2) Connect red test lead with A terminal, and black with COM. Then connect test lead with measured loop in series.
- 3) Read the measured current from the LCD. The displayed AC current is true RMS value.
- 4) When measuring AC current, short press SEL to switch to frequency measurement under AC current mode, then read from the LCD the frequency of measured current. For measuring frequency of current, the AC current amplitude shall be 600mA to 10A; the input amplitude shall be greater than 3A for frequency measurement at range of 10A. If the measured frequency is unstable, please select low current range manually for a stable readout. See “Technical Specifications” for details.
- 5) For frequency detection, analog bar graph and range indicator indicate the current AC current.

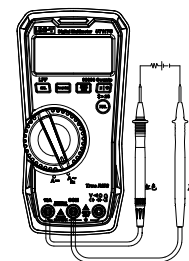

Figure 9

⚠ Warning:

- When turning the rotary switch to or from “ A ”, the LCD shows “LEAd” for about a second as a warning of testing lead.
- Please check if the fuse is good before measuring current. The instructions to check the fuse is as below:
Set the rotary switch to Ω position, then short-circuit V terminal and A terminal. If the displayed resistance is about 0.0 Ω , the fuse is good, otherwise damaged.

- Please switch off the current of measured loop before connecting the multimeter with the measured loop, otherwise it can present a risk of electric spark.
- Please select correct input terminal and set the rotary switch to correct position. If current value is unknown, please perform measurement starting from large current range. For measuring current over 10A, the measurement duration shall be less than 10 seconds and the measurement interval shall be greater than 15 minutes.
- If measured current is >10A, the display screen flashes; if >20A, "OL" or "-OL" is displayed.
- If test lead is connected with current input terminal, please do not connect test lead with any circuit in parallel, otherwise it can damage the burnt-in fuse and the multimeter.
- After all measurement operations are completed, please switch off the measured current source before disconnecting test lead with measured circuit, especially for large current measurement.

10. Non-contact AC voltage (NCV) detection (Figure 10)

- 1) Set the rotary switch to "NCV" (with LED lamp lit up red and "Lo" displayed). Short press SEL to switch sensitivity between "Lo" and "HI".
- 2) When the sensing end approaches electric fields such as outlet or insulated conductor, the buzzer makes a long beep and the red light is lit up.
- 3) "Lo" (Low sensitivity): Applied in wall-mounted outlets, power distribution units, industrial outlets, and multiple power cords. "HI" (High sensitivity): Applied in hidden outlets or connectors of power supply.

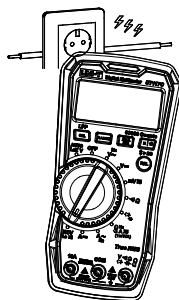

Figure 10

⚠ Warning:

- Please make the sensing end approach electric field when performing measurement, otherwise it can affect the sensitivity.
- If the voltage of measured electric field is $\geq 100V$ AC, please observe if the conductor of measured electric field is insulated, so as to avoid personal injury.

- Even the displayed result is that voltage is not present, it does not mean voltage is present. Do not determine if voltage is present simply by the NCV. Since the outlet design and the insulation thickness differ from one another, the operation results may be affected.

XII. Other Functions

1. Silent mode

The multimeter is designed with buzzer. When "MAX" button is held down, the multimeter is powered on and the LCD shows "BEEP" as indication. When releasing the button "MAX", the buzzer is disabled, the multimeter enters measurement state, and the symbol "🔇" is displayed on the LCD. To enable the buzzer, please power off the multimeter and then restart it.

2. Disable auto-off backlight

The multimeter is designed with auto-off backlight. When "HOLD" button is held down, the multimeter is powered on and the LCD shows "LoFF" as indication. When releasing the button "HOLD", the multimeter enters measurement state. To enable auto-off backlight function, please power off the multimeter and then restart it.

3. Disable auto-off function

To disable the auto-off function, please hold down "Select" button and then power on the multimeter (with the buzzer making five beeps and the symbol "🔄" disappeared at the same time).

4: Awakening function

Under sleep mode, the multimeter can be awakened by all buttons and the rotary switch.

5. Audible and visual alarm (not in silent mode)

1) Diode:

0.12V: The red light is lit up and the buzzer makes a long beep.

$\geq 0.12V$ and 2V: The green light is lit up and the buzzer sounds once.

>2V: The light is off.

2) Continuity:

$\leq 20\Omega$: The buzzer makes a long beep and the green light is lit up.

>20 Ω : The red light is lit up and the OL light is off.

3) Voltage (Range: 600V):

>600V: The red light is lit up.

XIII. Technical Specifications

Accuracy: \pm (a% of reading + b digits); guaranteed for one year

Ambient temperature: 23°C \pm 5°C

Relative humidity: < 75%

⚠ Note:

The temperature condition of accuracy is 18°C~28°C, the fluctuation range of ambient temperature keeps within \pm 1°C. If the temperature is <18°C or >28°C, the additional error of temperature coefficient is "0.1 \times (specified accuracy)/°C".

1. Auto-V LoZ (Auto AC/DC voltage)

Range	Resolution	Accuracy \pm (a% of reading +b digit)	Overload protection
600.0V	0.1V	\pm (1%+3)	600V AC/DC

* Input impedance: About 3K Ω

* Range to ensure accuracy: 1%~100% of range

* Least significant digit under short circuit: \leq 3 digits

* Auto-V LoZ: Select AC/DC voltage automatically according to the detected low impedance.

* Auto-V LoZ: The minimum measured AC voltage: 1V; the minimum measured DC voltage: 0V

* Auto-V LoZ: AC crest factor is up to 3 at 3000 counts, and is down to about 1.5 at 6000 counts. An additional error of \pm 0.5 % is added for non-sinusoidal wave.

2. DC voltage

Range	Resolution	Accuracy \pm (a% of reading +b digit)	Overload protection
600.00mV	0.01mV	\pm (0.3%+10)	600V AC/DC
6.0000V	0.0001V		
60.000V	0.001V		
600.00V	0.01V		

* Input impedance: About 10M Ω

* Range to ensure accuracy: 1%~100% of range

* Least significant digit under short circuit: \leq 2 digits

3. AC voltage

Range	Resolution	Accuracy \pm (a% of reading +b digit)	Overload protection
600.00mV	0.01mV	\pm 1 30	600V AC/DC
6.0000V	0.0001V		
60.000V	0.001V		
600.00V	0.01V		

* Display: True RMS of sinusoidal wave

* Input impedance: About 10M Ω

* Frequency response: 45Hz~1000Hz

* Range to ensure accuracy: 1%~100% of range. The least significant digit is allowed to be <5 digits at voltage range under short circuit.

* AC crest factor is up to 3 at 30000 counts, and is down to about 1.5 at 60000 counts. An additional error of \pm 0.5 % is added for non-sinusoidal wave.

* Frequency measurement condition: 1.1V < voltage input amplitude \leq 600V. When performing HZ measurement at 60V and 600V ranges, the frequency amplitude shall be greater than 10% of range, and the frequency accuracy is \pm (0.01%+3).

4. Low pass filter of AC voltage (LPF)

Range	Resolution	Accuracy \pm (a% of reading +b digit)	Overload protection
600.0V	0.1V	\pm (2%+3)	600V AC/DC

* Display: True RMS of sinusoidal wave.

* Input impedance: About 10M Ω

* Frequency response: 45Hz~100Hz

* Range to ensure accuracy: 5%~100% of range. The least significant digit under short circuit is allowed to be <5 digits.

* AC crest factor is up to 3 at 3000 counts, and is down to about 1.5 at 6000 counts. An additional error of \pm 0.5 % is added for non-sinusoidal wave.

* The 3db frequency of LPF: About 1.2 KHz.

* Frequency testing: The input amplitude shall be 10% of full range, and the accuracy is \pm (0.01%+3).

5. Frequency

Range	Resolution	Accuracy±(a% of reading +b digit)	Overload protection
99.99Hz	0.01Hz	± (0.01%+3)	ACV: 600Vrms ACA: F 11A / 1000V fuse
999.9Hz	0.1Hz		
9.999kHz	0.001kHz		
50.00kHz	0.01kHz		

- * Frequency measurement function is designed for ACV and ACA positions only.
- * Auto range
- * Accuracy range: ACV: 5 Hz~50 kHz
ACA: 45 Hz~5 kHz
- * Pulse width: >0.01mS, zero-crossing waveform
- * Input amplitude range:
ACV: 1.1V < input amplitude≤600V. The frequency amplitude shall be greater than10% of range when performing HZ measurement at 60V and 600V ranges.
ACA: 600mA < input amplitude≤10A. The input amplitude shall be greater than 3A when performing Hz measurement at 10A range.

6. DC current

Range	Resolution	Accuracy±(a% of reading +b digit)	Overload protection
6.0000A	0.0001A	± (0.5%+10)	F 11A /1000V
10.000A	0.001A		

- * Range to ensure accuracy: 1%~100% of range
- * The least significant digit at current range under open circuit is allowed to be <2.

⚠ Note:

- 10~20 A: Perform measurement continuously for 10 seconds at most, then stop for 15 minutes at least.
- > 10 A: The display screen flashes, and the reading is for reference only.
- > 20 A: OL is displayed.

7. AC current

Range	Resolution	Accuracy±(a% of reading +b digit)	Overload protection
6.0000A	0.0001A	± (1.5%+30)	F 11A /1000V
10.000A	0.001A		

- * Display: True RMS of sinusoidal wave
- * Range to ensure accuracy: 1%~100% of range
- * The least significant digit is allowed to be <2 at current range under open circuit.
- * AC crest factor is up to 3 at 30000 counts, and is down to about 1.5 at 60000 counts. An additional error of ± 0.5 % is added for non-sinusoidal wave.

⚠ Note:

- 10~20 A: Perform measurement continuously for 10 seconds at most, then stop for 15 minutes at least.
- > 10.00 A: The display screen flashes, and the reading is for reference only.
- > 20 A: OL is displayed.

8. Resistance

Range	Resolution	Accuracy±(a% of reading +b digit)	Overload protection
600.00Ω	0.01Ω	± (0.5%+10)	600V AC/DC
6.0000kΩ	0.0001kΩ	± (0.5%+2)	
60.000kΩ	0.001kΩ		
600.00kΩ	0.01kΩ		
6.0000MΩ	0.0001MΩ	± (0.5%+5)	
40.00MΩ	0.01MΩ	± (3%+5)	

- * 600Ω range: Measured value = Displayed value – Value of shorted test lead
- * Range to ensure accuracy: 1%~100% of range

9. Capacitance

Range	Resolution	Accuracy±(a% of reading +b digit)	Overload protection
1000nF	1nF	± (1.9%+5)	600V AC/DC
10.00μF	0.01μF		
100.0μF	0.1μF		
10000μF	1μF	± 2.5%+5)	

- * Auto range (Least significant digit is allowed to be 50 under open circuit.)
- * Range to ensure accuracy: 1%~100% of range
- * It is recommended to measure in REL mode if measured capacitance is ≤100nF.
- * "OL" is displayed if the input capacitance is ≥10000uF.

10. Continuity

Range	Resolution	Accuracy±(a% of reading +b digit)	Overload protection
600.00Ω	0.01Ω	Circuit open: The buzzer keeps silent with the resistance set at about ≥50Ω. Circuit connected: The buzzer sounds with the resistance set at about ≤20Ω.	600V AC/DC

- * Open circuit voltage: About 2V
- * The buzzer may sound if the resistance of circuit is 20Ω~250Ω.
- * The buzzer sounds with LED light flashing.

11. Diode

Range	Resolution	Accuracy±(a% of reading +b digit)	Overload protection
6.0000V	0.0001V	± (0.5%+10)	600V AC/DC

- * If the measured value is less than 0.1200V, the red light is lit up and the buzzer makes a long beep.
- * Least significant digit is allowed to be about 5 under short circuit.

12. Current probe measurement (ACA/DCA)

Function	Range	Resolution	Accuracy±(a% of reading +b digit)	Overload protection
ACA	600.0A	0.1A	± (1.8%+3)	600V AC/DC
DCA	600.0A	0.1A	± (0.8%+2)	

- * Frequency response: 45Hz~400Hz (Sinusoidal wave; frequency response refers to the intrinsic frequency response of UT117C)
- * Current probe measurement is an input mode of analog voltage, the conversion ratio is 1mV/1A, and the accuracy specified is the intrinsic accuracy of UT117C (eliminate the error of current probe).
- * Least significant digit is allowed to be about 5 under short circuit.

XIV. Bluetooth software

Bluetooth software

1. Introduction

The Bluetooth software is a mobile APP and supports iOS 10.0 or newer and Android 5.0 or newer currently.

2. Download (iDMM2.0)

For Android

Method 1: Open the mobile browser and scan the QR code below (Do not scan by WeChat)

Method 2: Search "iDMM2.0" at our official website.

Method 3: Search "iDMM2.0" at Myapp, HUAWEI APP store, MI APP store, OPPO APP store or VIVO APP store.

For IOS

Method 1: Open the scanning function of mobile phone and scan the QR code below (Do not scan by WeChat)

Method 2: Search "iDMM2.0" at "App Store".



(For IOS)



(For Android)

3. Use of the software

- 3.1 Long press "Rel" to turn on Bluetooth. The Bluetooth symbol flashes if the mobile APP is not connected after Bluetooth is turned on. Find the installed "iDMM2.0" APP icon on the mobile phone and tap the APP to open it. After the APP is turned on, it enters navigation interface, searches "UT117C" automatically, and displays "UT117C" in the "To be connected" list, then select "UT117C" to connect. Or scan the QR code at the multimeter to connect. After successful connection, the Bluetooth symbol is displayed on the LCD always, the measurement results can be displayed through the communication between "iDMM2.0" APP and UT117C, button control can be performed, etc.
- 3.2 The "iDMM2.0" APP has multiple functions including Bluetooth communication, data recording, device management, report generation, data sharing, data synchronizing, and more. Please refer to the use manual of "iDMM2.0" for use of these functions.

4. Uninstallation of the software

Uninstall the software through the uninstallation function of mobile phone.

XV. Use of magnetic hanger (UT-B23)

1. Overview and features

Magnetic hanger, composed of magnet and hanging strap, can be used to hang onto power distribution cabinet, photovoltaic combiner box, automobile engine hood, and others, allowing for hand-free measurement and helping in positioning of meter. The magnetic hanger is suitable for use with UT117C, UT15B MAX, UT17B MAX, UT18B MAX, etc.

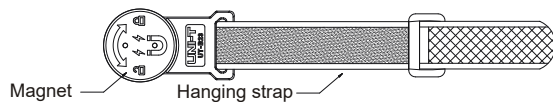

2. Installation

Select appropriate installation way (install from right or left side, as shown below), grip the magnet by hand, put the magnet into plastic housing, and rotate the magnet in a suitable direction. The magnet is held tightly due to the housing structure and the magnet structure.

Install from right side:

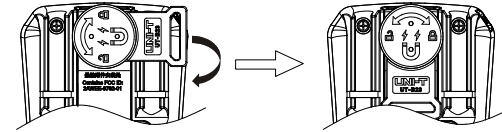

Install from left side:

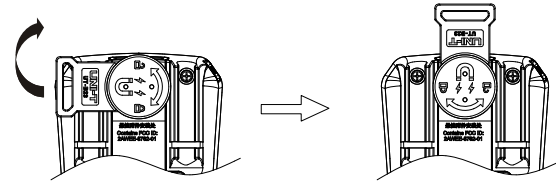

Installed with hanging strap form right side

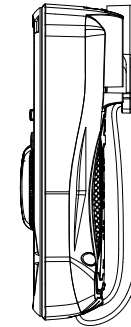

3. Application

Hang onto nail, hook or other objects, or attach to iron objects such as power distribution cabinet, photovoltaic combiner box, automobile engine hood, etc. As shown below:

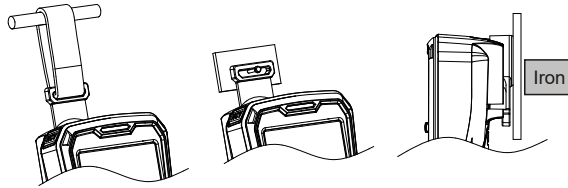

XVI. Maintenance and Repair

The multimeter is an advanced intelligent precise instrument. The maintenance must be carried out by authorized personnel with performance calibration skills and repair knowledges.

The multimeter is designed with auto calibration technology, all parts and components (except for specified replaceable ones) cannot be replaced without authorization, so as to avoid specification deviation.

1. General maintenance

- Please clean the multimeter with wet cloth and mild cleaning agent only, do not wipe the product surface with chemical solvent.
- If any problem with the multimeter is found, please stop use and send it for maintenance.
- The calibration and maintenance must be performed by qualified repair personnel or designated repair department.
- Power off the multimeter when not use. Remove the battery if not use for a long time.
- Do not keep in environments with high humidity, high temperature and strong electromagnetic fields.

2. Replace battery or fuse (Figure 11)

⚠ Warning:

(1) When the symbol "🔋" shows on the LCD, please replace the battery in time, otherwise the measurement accuracy can be affected. Battery specification: 1.5V AAA x3 (4.5V)

(2) If the display does not function at all when measuring current, please check if the built-in fuse is blown out. Please check the fuse as per the instructions below:

Set the rotary switch to Ω position, then short-circuit V terminal and A terminal. If the displayed resistance is about 0.0Ω , the fuse is good, otherwise damaged.

If the fuse is blown out, please replace it by a new one same in original specifications.

Fuse specification: 11A/1000V (energy: 30KA) $\Phi 10.3 \times 38$

Operating steps:

- Set the rotary switch to OFF position, then remove the test lead from input terminal.
- Battery replacement: Loosen the screw at the battery cover by screw driver, remove the battery cover, and replace the battery. Please install the battery according to the correct polarity.
- Loosen the two screws at the rear cover, remove the rear cover, and replace the blown fuse.

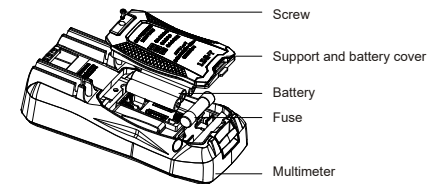

Figure 11